

# ■ Stereo ■ Turntable System

## Owner's Record

The model number and serial numbers are located at the rear. Record these numbers in the spaces provided below. Refer to these numbers whenever you call upon your Sony dealer regarding this product.

Model No. PS-LX300USB      Serial No. \_\_\_\_\_

## Operating Instructions PS-LX300USB

## WARNING

To reduce the risk of fire or electric shock, do not expose this apparatus to rain or moisture.

To prevent fire, do not cover the ventilation of the apparatus with news papers, table-cloths, curtains, etc. And don't place lighted candles on the apparatus.

To prevent fire or shock hazard, do not place objects filled with liquids, such as vases, on the apparatus.

Do not install the appliance in a confined space, such as a bookcase or built-in cabinet.

The unit is not disconnected from the AC power source (mains) as long as it is connected to the wall outlet, even if the unit itself has been turned off.

Install this system so that the power cord can be unplugged from the wall socket immediately in the event of trouble.

### Notice for the customers in the U.S.A.

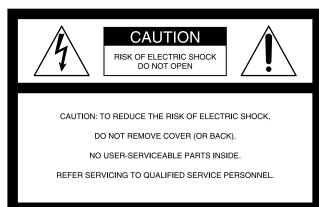

This symbol is intended to alert the user to the presence of uninsulated “dangerous voltage” within the product’s enclosure that may be of sufficient magnitude to constitute a risk of electric shock to persons.



This symbol is intended to alert the user to the presence of important operating and maintenance (servicing) instructions in the literature accompanying the appliance.

The Caution Marking is put on the Bottom Enclosure.

### Important Safety Instructions

- 1) Read these instructions.
- 2) Keep these instructions.
- 3) Heed all warnings.
- 4) Follow all instructions.
- 5) Do not use this apparatus near water.
- 6) Clean only with dry cloth.
- 7) Do not block any ventilation openings. Install in accordance with the manufacturer's instructions.
- 8) Do not install near any heat sources such as radiators, heat registers, stoves, or other apparatus (including amplifiers) that produce heat.
- 9) Do not defeat the safety purpose of the polarized or grounding-type plug. A polarized plug has two blades with one wider than the other. A grounding type plug has two blades and a third grounding prong. The wide blade or the third prong are provided for your safety. If the provided plug does not fit into your outlet, consult an electrician for replacement of the obsolete outlet.
- 10) Protect the power cord from being walked on or pinched particularly at plugs, convenience receptacles, and the point where they exit from the apparatus.
- 11) Only use attachments/accessories specified by the manufacturer.
- 12) Use only with the cart, stand, tripod, bracket, or table specified by the manufacturer, or sold with the apparatus. When a cart is used, use caution when moving the cart/apparatus combination to avoid injury from tip-over.
- 13) Unplug this apparatus during lightning storms or when unused for long periods of time.
- 14) Refer all servicing to qualified service personnel. Servicing is required when the apparatus has been damaged in any way, such as power-supply cord or plug is damaged, liquid has been spilled or objects have fallen into the apparatus, the apparatus has been exposed to rain or moisture, does not operate normally, or has been dropped.



### WARNING

This equipment has been tested and found to comply with the limits for a Class B digital device, pursuant to Part 15 of the FCC Rules. These limits are designed to provide reasonable protection against harmful interference in a residential installation. This equipment generates, uses, and can radiate radio frequency energy and, if not installed and used in accordance with the instructions, may cause harmful interference to radio communications.

However, there is no guarantee that interference will not occur in a particular installation. If this equipment does cause harmful interference to radio or television reception, which can be determined by turning the equipment off and on, the user is encouraged to try to correct the interference by one or more of the following measures:

- Reorient or relocate the receiving antenna.
- Increase the separation between the equipment and receiver.
- Connect the equipment into an outlet on a circuit different from that to which the receiver is connected.
- Consult the dealer or an experienced radio/TV technician for help.

### CAUTION

You are cautioned that any changes or modification not expressly approved in this manual could void your authority to operate this equipment.

If you have any questions about this product, you may call:

Sony Customer Information Services Center  
1-800-222-7669  
or <http://www.sony.com/>

#### Declaration of Conformity

Trade Name : SONY  
Model Name : PS-LX300USB (Stereo Turntable System)  
Responsible Party : Sony Electronics Inc.  
Address : 16450 W. Bernardo Dr, San Diego, CA92127 USA  
Telephone No. : 858-942-2230

This device complies with Part 15 of the FCC Rules. Operation is subject to the following two conditions. (1) This device may not cause harmful interference, and (2) this device must accept any interference received, including interference that may cause undesired operation.

### Notice for the customers in Canada

This class B digital apparatus complies with Canadian ICES-003.

### NOTICE FOR THE CUSTOMERS IN THE UNITED KINGDOM

A moulded plug complying with BS1363 is fitted to this equipment for your safety and convenience.

Should the fuse in the plug supplied need to be replaced, a fuse of the same rating as the supplied one and approved by ASTA or BSI to BS1362, (i.e., marked with ⚡ or ⚡ mark) must be used.

If the plug supplied with this equipment has a detachable fuse cover, be sure to attach the fuse cover after you change the fuse. Never use the plug without the fuse cover.

If you should lose the fuse cover, please contact your nearest Sony service station.

### Notice for the customers in the countries applying EU Directives

The manufacturer of this product is Sony Corporation, 1-7-1 Konan Minato-ku Tokyo, 108-0075 Japan. The Authorized Representative for EMC and product safety is Sony Deutschland GmbH, Hedelfinger Strasse 61, 70327 Stuttgart, Germany. For any service or guarantee matters please refer to the addresses given in separate service or guarantee documents.

### For the customers in Europe



#### Disposal of Old Electrical & Electronic Equipment (Applicable in the European Union and other European countries with separate collection systems)

This symbol on the product or on its packaging indicates that this product shall not be treated as household waste. Instead it shall be handed over to the applicable collection point for the recycling of electrical and electronic equipment. By ensuring this product is disposed of correctly, you will help prevent potential negative consequences for the environment and human health, which could otherwise be caused by inappropriate waste handling of this product. The recycling of materials will help to conserve natural resources. For more detailed information about recycling of this product, please contact your local Civic Office, your household waste disposal service or the shop where you purchased the product.

This equipment has been tested and found to comply with the limits set out in the EMC Directive using a connection cable shorter than 3 meters.

# Table of Contents

About This Manual..... 4

## Getting Started

Unpacking..... 5  
Assembling the Turntable ..... 5  
Hooking Up the Turntable ..... 7

## Operations

Playing a Vinyl Record ..... 8  
Recording Audio Tracks on  
Your Computer ..... 9

## Additional Information

Precautions ..... 13  
Maintenance..... 14  
Troubleshooting..... 15  
Specifications ..... 18  
Parts and Controls ..... 19

# About This Manual

Thank you for purchasing the Sony Stereo Turntable System. Before operating the unit, please read this manual thoroughly and retain it for future reference.

- IBM and PC/AT are registered trademarks of International Business Machines Corporation.
- Microsoft, Windows and Windows Vista are either registered trademarks or trademarks of Microsoft Corporation in the United States and / or other countries.
- In this manual, Microsoft® Windows® XP Home Edition and Microsoft® Windows® XP Professional are referred to as Windows XP.
- In this manual, Microsoft® Windows Vista® Home Basic, Windows Vista® Home Premium, Windows Vista® Business, and Windows Vista® Ultimate are referred to as Windows Vista.
- Sound Forge is a trademark or registered trademark of Sony Creative Software Inc. in the United States and other countries.
- All other names of systems and products are trademarks or registered trademarks of their respective owners.™ and ® marks are omitted in this manual.

## Getting Started

### Unpacking

Check that you received the following items with your turntable:

- Platter (with drive belt) (1)
- Rubber mat (1)
- 45 r/min adaptor (1)
- USB cable (1)
- CD-ROM, “Sound Forge Audio Studio LE” included (1)
- Operating Instructions (this manual)
- The installation guide for “Sound Forge Audio Studio LE”
- Recording audio tracks of a vinyl record to your computer
- Please read this first.

### Assembling the Turntable

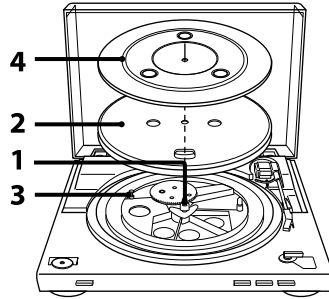

- 1 Move the metallic parts inside the larger gear in the direction of the arrow.

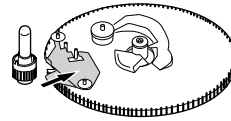

- 2** Carefully place the platter on the spindle.

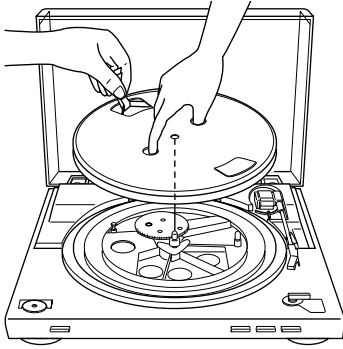

- 3** Using the ribbon, loop the drive belt around the motor pulley.

After looping the belt, do not forget to remove the ribbon.

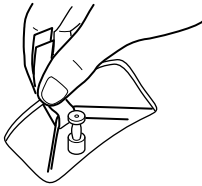

- 4** Place the rubber mat on the platter.

**Note**

When the AC power cord is plugged after assembling or moving the turntable, the turntable sometimes rotates and the tone arm descends to the platter even if START is not pressed.

If this occurs, press STOP to return the tone arm to the arm stand.

**To remove the dust cover**

With the dust cover fully opened, grasp both sides of the cover, then remove it carefully.

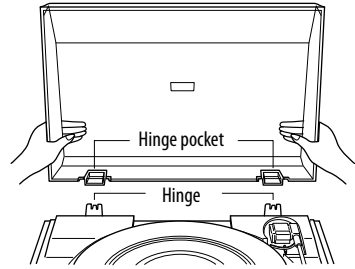

**Tip**

You can use the turntable leaving the dust cover removed. In that case, store the cover correctly.

**To install the dust cover**

Insert the hinge pockets on the dust cover into the hinges on the rear of the cabinet.

# Hooking Up the Turntable

The phono cable comes attached to the rear of the cabinet.

- 1 Set the PHONO/LINE switch (on the rear of the turntable) according to the jacks of your stereo system (amplifier).

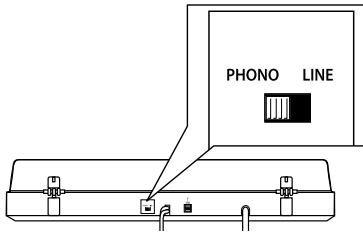

- When your stereo system (amplifier) has PHONO input jacks (connect to PHONO input jacks)  
→set to PHONO. The Equalizer function is off.
- When your stereo system (amplifier) does not have PHONO input jacks (connect to AUX, VIDEO input jacks, etc.)  
→set to LINE. The Equalizer function is on.

- 2 Connect the cable with the white plug to the white (L) jack and connect the cable with the red plug to the red (R) jack.

Make sure to insert the plugs firmly into the jacks. If the plugs are not inserted firmly, noise may occur.

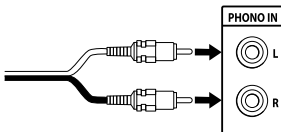

- 3 Connect the AC power cord.  
Connect the AC power cord to an AC wall outlet after completing all of the connections by performing steps 1 and 2.

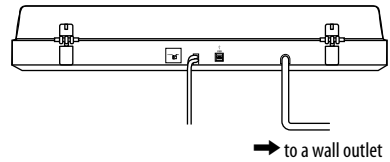

## Operations

### Playing a Vinyl Record

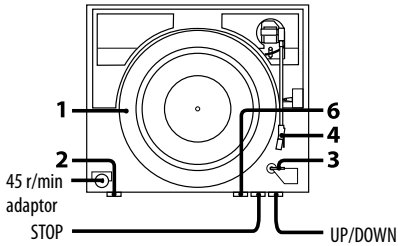

- 1 Place a vinyl record on the platter.

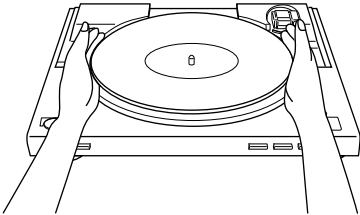

#### Note

Place only one vinyl record on the platter at a time. If two or more vinyl records are stacked on the platter, the stylus will not make proper contact with the grooves and the quality of reproduction will be impaired.

- 2 Press the Speed select button to select the speed.

- 3 Set the SIZE SELECTOR to 17 or 30.
- 4 Turn the protective cover to expose the stylus.
- 5 Close the dust cover.
- 6 Press START.  
The platter starts rotating.

#### Note

Lower the volume of the amplifier to prevent damage to it. If the tone arm descends and the stylus touches the vinyl record, a loud creaking noise may occur and harm the amplifier or speakers. Adjust the volume of the amplifier after the stylus descends.

- 7 Adjust the volume on your amplifier.

#### When playback is finished

The tone arm returns to the arm stand automatically, then the platter stops rotating.

#### To stop playing

Press the STOP button.

The tone arm returns to the arm stand.  
The platter stops rotating.

**To pause playing**

Press the UP/DOWN button to raise the stylus off the vinyl record.

**To play a different part of the vinyl record**

- 1 After performing step 4, press the UP/DOWN button, then lift the tone arm.
- 2 Move the tone arm to the position you desire.
- 3 Press the UP/DOWN button.  
The tone arm descends to the record, then playback starts.

**To play a 17-cm vinyl record**

Place the supplied 45 r/min adaptor on the spindle.

When you have finished using the adaptor, put it back in the adaptor tray.

---

## Recording Audio Tracks on Your Computer

You can record audio tracks of a vinyl record on your computer by:

- Connecting the turntable and your computer using the supplied USB cable
- Using the supplied software, “Sound Forge Audio Studio LE”

**System requirements for the computer to be connected to the turntable\***

- Compliant computer:  
IBM PC/AT or compatible computers
  - Operating systems:  
Windows Vista® Home Basic  
Windows Vista® Home Premium  
Windows Vista® Business  
Windows Vista® Ultimate  
Windows® XP Home Edition Service Pack 2 or higher  
Windows® XP Professional Service Pack 2 or higher  
Pre-installed (manufacturer installed only)
    - Operating systems other than those listed above are not supported.
    - 64bit operating systems are not supported.
  - Hardware Environment:
    - Port: USB port\*\*
- \* Required when recording audio tracks of a vinyl record onto a computer via a USB connection.
- \*\*The USB jack of the turntable supports USB (full-speed).

**Notes**

- For the operating environment mentioned above, the turntable is not guaranteed to operate with all computers.
- The turntable is not guaranteed to operate with home built computers, operating systems that are personally up-graded or multiple operating systems.
- The turntable is not guaranteed to operate with functions such as system suspend, sleep (stand-by mode) and hibernation, on all computers.

## Installing the supplied software

Before recording, install the supplied software, “Sound Forge Audio Studio LE.”

Once you install the software into your computer, you do not have to install it again other than that you need to re-install it.

- 1 Insert the supplied CD-ROM into the CD drive of your computer.

- 2 Install the software according to on-screen instructions.

### Tip

For details about installing the software, refer to the “Sound Forge Audio Studio LE” installation guide.

## Connecting the USB cable

Connect the turntable and the computer with the supplied USB cable.

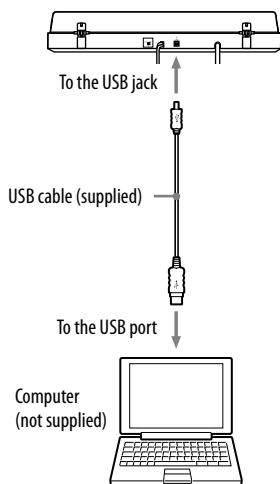

## Notes

- The turntable is not guaranteed to operate with a USB hub or USB extension cable. Use the supplied USB cable.
- Connect the USB cable into the USB jack/USB port securely, or may cause a malfunction.
- Disconnect the USB cable when it is not in use.
- When the turntable and computer are connected via USB cable, the audio that is adjusted with the turntable equalizer is input to the USB port of the computer, when playing the turntable to record audio tracks on your computer.

### Tip

USB drivers are included in operating systems if you are using Windows XP or Windows Vista. USB drivers will be installed automatically when the system is connected to the computer for the first time. For details, refer to the manual of your computer.

## Setting your computer

Before recording, set the recording audio device according to the operation system you use as follows:

- For Windows XP  
([Control Panel] is in [Category View])
- 1 Select [Control Panel] from the [Start] menu.
  - 2 Click [Sounds, Speech, and Audio Devices].
  - 3 Click [Sounds and Audio Devices].
  - 4 Click the [Audio] tab.
  - 5 Select [USB Audio CODEC] for [Default device:] of [Sound recording].
  - 6 Click [OK].

- For Windows Vista ([Control Panel] is in the [Control Panel Home] view)

- 1 Select [Settings] from the [Start] menu.
- 2 Select [Control Panel].
- 3 Click [Hardware and Sound].
- 4 Click [Sound].
- 5 Click the [Recording] tab.
- 6 Select [USB Audio CODEC] for [Microphone].
- 7 Click [Set default].
- 8 Select [USB Audio CODEC], then click [Properties].
- 9 Click the [Advanced] tab.
- 10 Select [2 channel, ...] (ex: [2 channel, 16 bit, 44100 Hz (CD Quality)]) from the [Default Format] drop-down list.
- 11 Click [OK].

**Note**

To input stereo signal from the turntable to the computer, performing steps 8 through 11 is necessary.

## Recording audio tracks from the turntable on a computer

For details on recording operations, refer to the supplied document titled “Recording audio tracks of a vinyl record to your computer.”

For details about using the software, refer to the “Sound Forge Audio Studio LE” quick start guide (on the supplied CD-ROM) or on-line help of the software.

## Reference guides for the supplied software

Refer to the following instructions:

- The installation guide for “Sound Forge Audio Studio LE”:  
Refer to this supplied manual to install “Sound Forge Audio Studio LE.”
- The “Sound Forge Audio Studio LE” tutorial:  
This tutorial provides easy instructions on how to operate the software. After installing the software, the tutorial appears when you launch the software for the first time.
- The “Sound Forge Audio Studio LE” quick start guide (on the supplied CD-ROM):  
This provides instructions on the basic operation of the software.

## Additional Information

### Precautions

#### On safety

- Before operating the unit, check that the operating voltage of your unit is identical with that of your local power supply.
- Should any solid object or liquid fall into the cabinet, unplug the unit and have it checked by qualified personnel before operating it any further.
- Unplug the unit from the wall outlet if it is not to be used for an extended period of time. To disconnect the cord, pull it out by the plug. Never pull the cord itself.

#### On placement

- Place the unit on a level surface.
- Avoid placing the unit near electrical appliances (such as a television, hair dryer, or fluorescent lamp) which may cause hum or noise.
- Place the unit where it will not be subject to any vibration, such as from speakers, slamming of doors, etc.
- Keep the unit away from direct sunlight, extremes of temperature, and excessive dust and moisture.

#### On repacking

Keep the carton and packing materials. They provide an ideal container to transport the unit.

If you have any question or problem concerning your unit that is not covered in this manual, please consult your nearest Sony dealer.

#### Note on recording

The recorded music is limited to private use only. Use of the music beyond this limit requires permission of the copyright holders.

## Maintenance

### Stylus and record care

In order to prevent premature stylus and record wear, the stylus and record should be cleaned before playback.

To clean the stylus, brush it from back to front using a good quality stylus cleaning brush. Do not clean the stylus with your finger tip. When using a fluid stylus cleaner, make sure not to moisten the stylus too much.

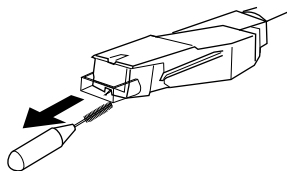

To clean your records, wipe thoroughly using a good quality record cleaner.

### Cleaning the cabinet and dust cover

Clean the cabinet and dust cover periodically using a soft dry cloth. If stains are difficult to remove, use a cloth moistened with a mild detergent solution. Do not use solvents such as alcohol, benzine or thinner, since they will damage the finish.

### Replacing the stylus

The life expectancy of the stylus tip is about 500 hours. To preserve good sound quality and avoid damage to your records, we recommend replacing the stylus within this time limit.

For a replacement stylus, consult your nearest Sony dealer.

#### To remove the stylus

- 1 Turn off and unplug the AC power cords of the turntable and amplifier.
- 2 Protect the stylus with the stylus cover.

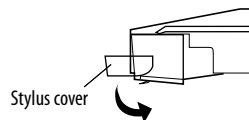

- 3 Grasp the stylus holder and pull it downward away from the body of the cartridge/headshell as shown.

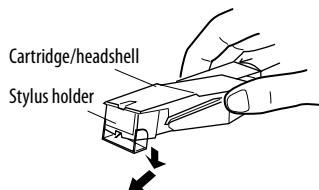

## To install the stylus

Do this procedure with the stylus protected by the stylus cover.

- 1 Grasp both sides of the stylus holder, then insert the stylus grip into the cartridge/headshell receptacle.

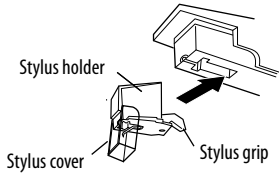

- 2 Push up the stylus holder until it clicks so that it locks completely.

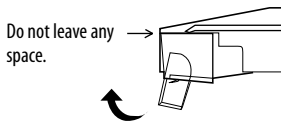

### Note

Do not push the stylus cover forcefully. Otherwise, the exposed stylus from the cover may cause injury, or damage the stylus.

## Troubleshooting

Before going through the check list below, first make sure that:

- The power cord is securely connected.
  - The speaker cords are securely connected.
- Should any problem persist after you have made these checks, consult your nearest Sony dealer.

## Playing a vinyl record

### The tone arm skips, skates or does not advance.

- The turntable is not level. Place the turntable on a level surface.
- The record is dirty or scratched.  
Clean the record with a commercially available record cleaning kit, or replace the record.

### Poor sound quality, excessive noise, intermittent sound, etc...

- The stylus is dirty or worn. Remove dust on the stylus using a stylus cleaning brush, or replace the worn stylus (see page 14).
- Dust or dirt has collected on the vinyl record. Clean the record using a good quality record cleaner.

### **Rumble or low-frequency howl\*.**

- The turntable is placed too close to speakers. Move speakers away from the turntable.
- \* This phenomenon, called “acoustic feedback”, occurs when vibrations from the speakers are transmitted through the air or via solid objects (such as shelves, a cabinet, or the floor) to the turntable where they are picked up by the stylus, amplified and reproduced through the speakers.

### **Tempo is incorrect.**

- Incorrect r/min. Set the r/min setting to match the one indicated on the vinyl record. (Select “33” for 33 1/3 r/min records or “45” for 45 r/min records.)

### **The drive belt is deteriorated.**

- Replace the drive belt. For details, consult your nearest Sony dealer.

### **Platter does not rotate.**

- Make sure the power cord is inserted all the way into an AC wall outlet.
- Make sure that the drive belt is looped around the motor pulley completely.

### **The drive belt is broken.**

- Replace the drive belt. For details, consult your nearest Sony dealer.

### **Sound is too low or distorted.**

- The turntable is not connected to the PHONO IN inputs on the amplifier (see page 7).

## **USB connection/recording**

### **The turntable is not detected on your computer.**

- Disconnect the supplied USB cable, and connect it again.
- With the turntable and the computer connected, restart the computer.
- Disconnect the supplied USB cable, and restart the computer. After restarting, connect the computer and the turntable with the supplied USB cable.
- The device setting of your computer may not be set correctly.
  - If the turntable is connected to the computer with the USB cable for the first time, the USB Composite Device, HID-compliant consumer control device, USB Human Interface Device and USB Audio Device (Windows XP)/USB Audio CODEC (Windows Vista) are installed automatically. To confirm if the driver is correctly installed, check as follows:
    - For Windows XP  
([Control Panel] is in [Category View])
      - 1 Select [Control Panel] from the [Start] menu.
      - 2 Click [Performance and Maintenance].
      - 3 Click [System].
      - 4 Click the [Hardware] tab, and then click [Device manager].
      - 5 Check the [Device manager] screen. Check the devices installed as follows.
        - [USB Human Interface Devices] and [HID-compliant consumer control device] under [Human Interface Devices]
        - [USB Audio Device] under [Sound, video and game controllers]
        - [USB Composite Device] under [Universal Serial Bus controllers]

- For Windows Vista ([Control Panel] is in the [Control Panel Home] view)

1 Select [Settings] from the [Start] menu.

2 Select [Control Panel].

3 Select [System and Maintenance].

4 Select [Device Manager].

5 Check the [Device manager] screen.

Check the devices installed as follows.

- [USB Human Interface Devices] and [HID-compliant consumer control device] under [Human Interface Devices]
- [USB Audio CODEC] under [Sound, video and game controllers]
- [USB Composite Device] under [Universal Serial Bus controllers]

#### Notes

- When connecting to different USB ports, you may have to install USB drivers.
- When connecting to different USB ports, the computer automatically installs the driver again. In such case, check that the driver is correctly installed as in this procedure.

#### The recorded sound is disrupted.

- The CPU of your computer is overloaded. Exit other applications.
- Other USB devices are connected to your computer and being operated simultaneously. Quit operating other USB devices.

#### You cannot record sound from the turntable.

- The audio recording device of your computer is not set correctly. See pages 10 and 11 to check the device settings.

#### There is noise in recorded sound.

- There are electrical wires, fluorescent lights or mobile phones near the turntable. Move away from any possible sources of electromagnetic interference.

#### Notes

- For details on the operation of your computer, refer to the operating instructions of your computer.
- There can be some breakdowns that cannot be solved even with Troubleshooting. In such cases, contact your nearest Sony dealer.

---

# Specifications

## Motor and Platter

- Drive system:
  - Belt-drive
- Motor:
  - DC motor
- Platter:
  - 295 mm dia. (aluminum die-cast)
- Speeds:
  - 33 1/3 and 45 r/min, 2 speed
- Wow and flutter:
  - Less than 0.25% (WRMS)
- Signal to noise ratio:
  - More than 50 dB (DIN-B)

## Tone Arm

- Type:
  - Dynamic balanced straight-shaped with soft damping control
- Effective arm length:
  - 195 mm

## USB jack

- Power supply:
  - USB bus power compliant (5 V, 100 mA)
  - (The power is supplied by the PC which is connected with an attached USB cable)
- Output jack:
  - Plug-in-power system (Dedicated USB jack)
  - USB series B connector
  - USB (full-speed)

## General

- Power requirements:
  - North American model:
    - 120 V AC, 60 Hz
  - Other models:
    - 230 – 240 V AC, 50/60 Hz
- Power consumption:
  - 2 W
- Dimensions:
  - Approx. 420 × 95 × 360 mm (16 1/2 × 3 5/8 × 14 1/4 in) (w/h/d)
- Mass:
  - 3.3 kg (7 lb 5 oz)
- Supplied Accessories:
  - 45 r/min adaptor (1)
  - Platter (with drive belt) (1)
  - Rubber mat (1)
  - USB cable (1)
  - CD-ROM (1)
  - Operating Instructions (this manual)
  - The installation guide for “Sound Forge Audio Studio LE”
  - Recording audio tracks of a vinyl record to your computer
  - Please read this first.

Design and specifications are subject to change without notice.

# Parts and Controls

- |                           |                      |
|---------------------------|----------------------|
| 1 Spindle                 | 10 Hinge             |
| 2 45 r/min adaptor        | 11 Tone arm          |
| 3 Speed select button     | 12 Arm stand         |
| 4 Rubber mat              | 13 Finger lift       |
| 5 Platter                 | 14 SIZE SELECTOR     |
| 6 Cartridge and headshell | 15 STOP button       |
| 7 START button            | 16 UP/DOWN button    |
| 8 Insulator               | 17 PHONO/LINE switch |
| 9 Dust cover              | 18 USB jack          |

Front

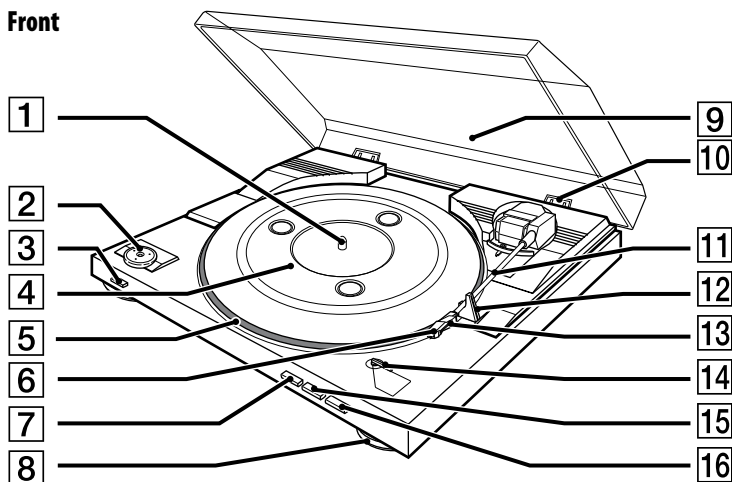

Rear

