

SONY®

***TFT LCD Color
Computer Display***

***SDM-HX73
SDM-HX93***

Owner's Record

The model and serial numbers are located at the rear of the unit. Record these numbers in the spaces provided below. Refer to them whenever you call upon your dealer regarding this product.

Model No. _____ Serial No. _____

WARNING

To prevent fire or shock hazard, do not expose the unit to rain or moisture.

Dangerously high voltages are present inside the unit. Do not open the cabinet. Refer servicing to qualified personnel only.

FCC Notice

This equipment has been tested and found to comply with the limits for a Class B digital device, pursuant to Part 15 of the FCC Rules. These limits are designed to provide reasonable protection against harmful interference in a residential installation. This equipment generates, uses, and can radiate radio frequency energy and, if not installed and used in accordance with the instructions, may cause harmful interference to radio communications. However, there is no guarantee that interference will not occur in a particular installation. If this equipment does cause harmful interference to radio or television reception, which can be determined by turning the equipment off and on, the user is encouraged to try to correct the interference by one or more of the following measures:

- Reorient or relocate the receiving antenna.
 - Increase the separation between the equipment and receiver.
 - Connect the equipment into an outlet on a circuit different from that to which the receiver is connected.
 - Consult the dealer or an experienced radio/TV technician for help.
- You are cautioned that any changes or modifications not expressly approved in this manual could void your authority to operate this equipment.

IMPORTANTE

Para prevenir cualquier mal funcionamiento y evitar daños, por favor, lea detalladamente este manual de instrucciones antes de conectar y operar este equipo.

**If you have any questions about this product, you may call;
Sony Customer Information Services Center
1-800-222-7669 or <http://www.sony.com/>**

Declaration of Conformity

Trade Name: SONY
Model: SDM-HX73/HX93
Responsible Party: Sony Electronics Inc.
Address: 16450 W. Bernardo Dr,
San Diego, CA 92127 U.S.A.
Telephone Number: 858-942-2230

This device complies with part 15 of the FCC rules. Operation is subject to the following two conditions: (1) This device may not cause harmful interference, and (2) this device must accept any interference received, including interference that may cause undesired operation.

NOTICE

This notice is applicable for USA/Canada only. If shipped to USA/Canada, install only a UL LISTED/CSA LABELLED power supply cord meeting the following specifications:

SPECIFICATIONS

Plug Type	Nema-Plug 5-15p
Cord	Type SVT or SJT, minimum 3 × 18 AWG
Length	Maximum 15 feet
Rating	Minimum 7 A, 125 V

NOTICE

Cette notice s'applique aux Etats-Unis et au Canada uniquement.

Si cet appareil est export* aux Etats-Unis ou au Canada, utiliser le cordon d'alimentation portant la mention UL LISTED/CSA LABELLED et remplissant les conditions suivantes:

SPECIFICATIONS

Type de fiche	Fiche Nema 5-15 broches
Cordon	Type SVT ou SJT, minimum 3 × 18 AWG
Longueur	Maximum 15 pieds
Tension	Minimum 7 A, 125 V

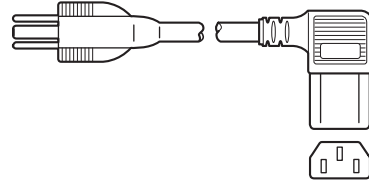

















As an ENERGY STAR Partner, Sony Corporation has determined that this product meets the ENERGY STAR guidelines for energy efficiency.



BZ03

Table of Contents

Precautions	4
Identifying parts and controls	5
Setup	7
Setup 1: Connect the video signal cables	7
Setup 2: Connect the audio cord	8
Setup 3: Connect the power cord	8
Setup 4: Bundle the cords and cables	9
Setup 5: Turn on the monitor and computer	9
Setup 6: Adjust the tilt and swivel	10
Selecting the input signal (INPUT button)	11
Customizing Your Monitor	12
Navigating the menu	12
 PICTURE/AUDIO menu	13
MODE menu	13
PICTURE menu 	13
Adjusting the BACKLIGHT 	13
Adjusting the CONTRAST 	13
Adjusting the BRIGHTNESS 	14
Adjusting the GAMMA γ	14
Adjusting the COLOR 	14
Adjusting the SHARPNESS	15
AUDIO menu 	15
Adjusting TREBLE, BASS or BALANCE	15
Adjusting SURROUND	15
MODE RESET menu (resetting every mode to the default) 	15
 SCREEN menu (analog RGB signal only)	16
 MENU POSITION menu	17
 INPUT SENSING ON/OFF menu	17
 LANGUAGE menu	18
 RESET menu (reset to the default setting)	18
 MENU LOCK menu	18
Technical Features	19
Controlling the volume	19
Power saving function	19
Setting the MODE (PICTURE/AUDIO) ( mode)	20
Automatic brightness adjustment function (light sensor)	20
Automatic picture quality adjustment function (analog RGB signal only)	20
Troubleshooting	21
On-screen messages	21
Trouble symptoms and remedies	22
Self-diagnosis function	24
Specifications	25

- Macintosh is a trademark licensed to Apple Computer, Inc., registered in the U.S.A. and other countries.
- Windows® is registered trademark of Microsoft Corporation in the United States and other countries.
- IBM PC/AT and VGA are registered trademarks of IBM Corporation of the U.S.A.
- VESA and DDC™ are trademarks of the Video Electronics Standards Association.
- ENERGY STAR is a U.S. registered mark.
- Adobe and Acrobat are trademarks of Adobe Systems Incorporated.
- WOW, SRS and  symbol are trademarks of SRS Labs, Inc.
- WOW technology is incorporated under license from SRS Labs, Inc.
- All other product names mentioned herein may be the trademarks or registered trademarks of their respective companies.
- Furthermore, “™” and “®” are not mentioned in each case in this manual.

Precautions

Warning on power connections

- Use the supplied power cord. If you use a different power cord, be sure that it is compatible with your local power supply.

For the customers in the U.S.A.

If you do not use the appropriate cord, this monitor will not conform to mandatory FCC standards.

For the customers in the UK

If you use the monitor in the UK, be sure to use the appropriate UK power cord.

Example of plug types

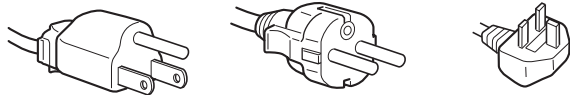

for 100 to 120 V AC for 200 to 240 V AC for 240 V AC only

The equipment should be installed near an easily accessible outlet.

Installation

Do not install or leave the monitor:

- In places subject to extreme temperatures, for example near a radiator, heating vent, or in direct sunlight. Subjecting the monitor to extreme temperatures, such as in an automobile parked in direct sunlight or near a heating vent, could cause deformations of the casing or malfunctions.
- In places subject to mechanical vibration or shock.
- Near any equipment that generates a strong magnetic field, such as a TV or various other household appliances.
- In places subject to inordinate amounts of dust, dirt, or sand, for example near an open window or an outdoor exit. If setting up temporarily in an outdoor environment, be sure to take adequate precautions against airborne dust and dirt. Otherwise irreparable malfunctions could occur.

Handling the LCD screen

- Do not leave the LCD screen facing the sun as it can damage the LCD screen. Take care when you place the monitor by a window.
- Do not push on or scratch the LCD screen. Do not place a heavy object on the LCD screen. This may cause the screen to lose uniformity or cause LCD panel malfunctions.
- If the monitor is used in a cold place, a residual image may appear on the screen. This is not a malfunction. The screen returns to normal as the temperature rises to a normal operating level.
- If a still picture is displayed for a long time, a residual image may appear for a while. The residual image will eventually disappear.
- The LCD panel becomes warm during operation. This is not a malfunction.

About the built-in stereo speakers

Be sure to keep magnetic recording equipment, tapes, and floppy discs away from the speaker's opening as the speakers generate a magnetic field. This magnetic field may affect data stored on magnetic tapes and discs.

Note on the LCD (Liquid Crystal Display)

Please note that the LCD screen is made with high-precision technology. However, black points or bright points of light (red, blue, or green) may appear constantly on the LCD screen, and irregular colored stripes or brightness may appear on the LCD screen. This is not malfunction.

(Effective dots: more than 99.99%)

Maintenance

- Be sure to unplug the power cord from the power outlet before cleaning your monitor.
- Clean the LCD screen with a soft cloth. If you use a glass cleaning liquid, do not use any type of cleaner containing an anti-static solution or similar additive as this may scratch the LCD screen's coating.
- Clean the cabinet, panel, and controls with a soft cloth lightly moistened with a mild detergent solution. Do not use any type of abrasive pad, scouring powder, or solvent, such as alcohol or benzene.
- Do not rub, touch, or tap the surface of the screen with sharp or abrasive items such as a ballpoint pen or screwdriver. This type of contact may result in a scratched picture tube.
- Note that material deterioration or LCD screen coating degradation may occur if the monitor is exposed to volatile solvents such as insecticide, or if prolonged contact is maintained with rubber or vinyl materials.

Transportation

- Disconnect all cables from the monitor, and grasp both side of the LCD display firmly taking care not to scratch the screen when transporting. If you drop the monitor, you may be injured or the monitor may be damaged.
- When you transport this monitor for repair or shipment, use the original carton and packing materials.

Disposal of the monitor

- **Do not dispose of this monitor with general household waste.**
- **The fluorescent tube used in this monitor contains mercury. Disposal of this monitor must be carried out in accordance to the regulations of your local sanitation authority.**

Identifying parts and controls

See the pages in parentheses for further details.

Front of the LCD display

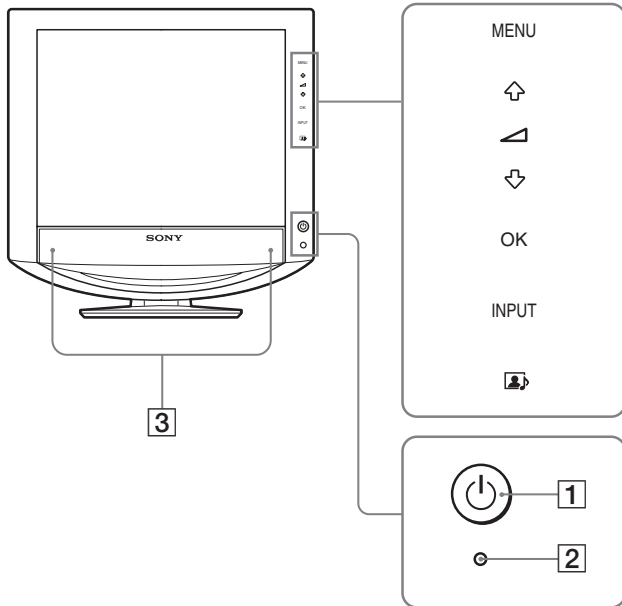

Side view of the LCD display

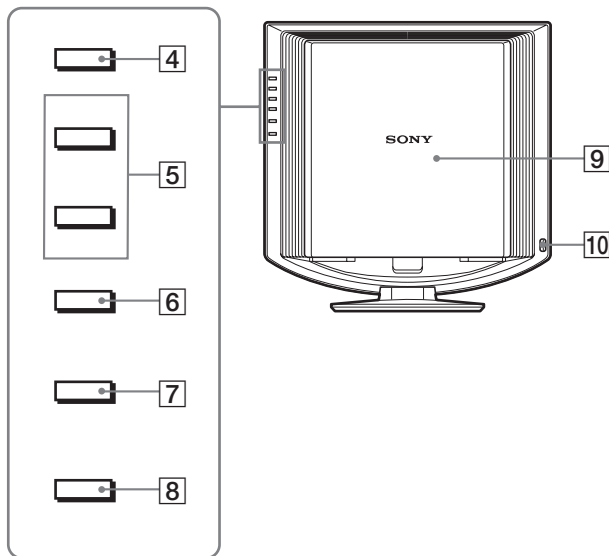

1 (Power) switch and (power) indicator (pages 9, 19, 24)

To turn the display on or off, press the (power) switch. The power indicator lights up in green when the display is turned on, and lights up in orange when the display is in the power saving mode.

2 Light sensor (page 20)

This sensor measures the brightness of the surrounding area. Be sure not to cover the sensor with papers, etc.

3 Stereo speakers (page 19)

These speakers output the audio signals as sound.

4 MENU button (page 12)

This button turns the menu screen on and off.

5 and (volume control) buttons (pages 12, 19)

These buttons are used to select the menu items and make adjustments, and also display the “Volume” menu to control the volume.

6 OK button (page 12)

This button activates the selected menu item and adjustments made using the buttons (5).

7 INPUT button (page 11)

This button switches the video input signal between INPUT1, INPUT2 and INPUT3 when two computers are connected to the monitor.

8 button (page 20)

This button changes the MODE (PICTURE/AUDIO).

9 Back cover (page 7)

Slide up this cover when you connect cables or cords.

10 Headphones jack (page 19)

This jack outputs audio signals to the headphones.

GB

(continued)

Rear of the LCD display

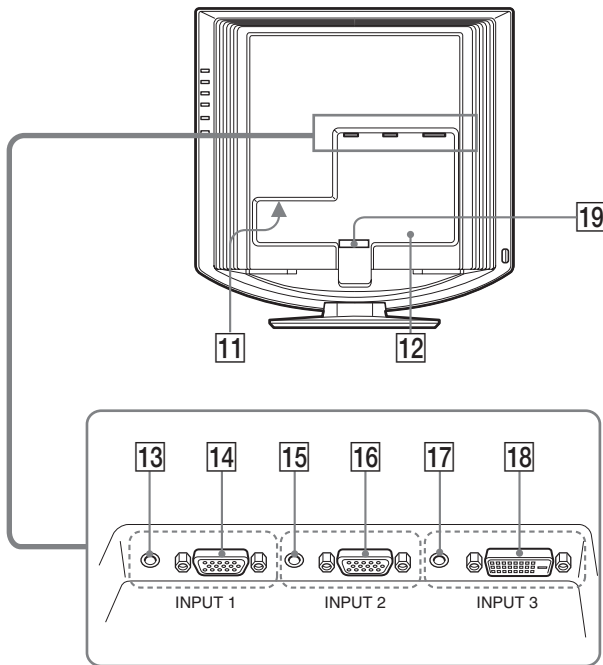

11 AC IN connector (page 8)

This connector connects the power cord (supplied).

12 Security Lock Hole

The security lock hole should be used with the Kensington Micro Saver Security System. Micro Saver Security System is a trademark of Kensington.

13 Audio input jack for INPUT1 (page 8)

This jack inputs audio signals when connected to the audio output jack of a computer or other audio equipment connected to INPUT1.

14 HD15 input connector (analog RGB) for INPUT1 (page 7)

This connector inputs analog RGB video signals (0.700 Vp-p, positive) and sync signals.

15 Audio input jack for INPUT2 (page 8)

This jack inputs audio signals when connected to the audio output jack of a computer or other audio equipment connected to INPUT2.

16 HD15 input connector (analog RGB) for INPUT2 (page 7)

This connector inputs analog RGB video signals (0.700 Vp-p, positive) and sync signals.

17 Audio input jack for INPUT3 (page 8)

This jack inputs audio signals when connected to the audio output jack of a computer or other audio equipment connected to INPUT3.

18 DVI-D input connector (digital RGB) for INPUT3 (page 7)

This connector inputs digital RGB video signals that comply with DVI Rev.1.0.

19 Cable holder (page 9)

This part secures cables and cords to the monitor.

Setup

Before using your monitor, check that the following items are included in your carton:

- LCD display
- Power cord
- HD15-HD15 video signal cable (analog RGB)
- DVI-D video signal cable (digital RGB)
- Audio cord (stereo miniplug)
- CD-ROM (utility software for Windows/Macintosh, Operating Instructions, etc)
- Warranty card
- Quick Setup Guide

Setup 1: Connect the video signal cables

- Turn off the monitor and computer before connecting them.
- When connecting the computer to the monitor's HD15 input connector (analog RGB), refer to "Connect a computer equipped with an HD15 output connector (analog RGB)."

Note

Do not touch the pins of the video signal cable connector as this might bend the pins.

Slide up the back cover.

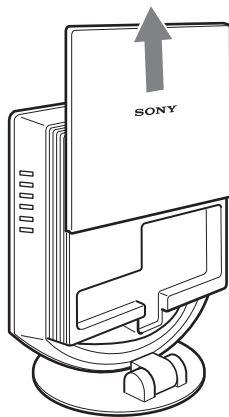

Connect a computer equipped with a DVI output connector (digital RGB)

Using the supplied DVI-D video signal cable (digital RGB), connect the computer to the monitor's DVI-D input connector (digital RGB) for INPUT3.

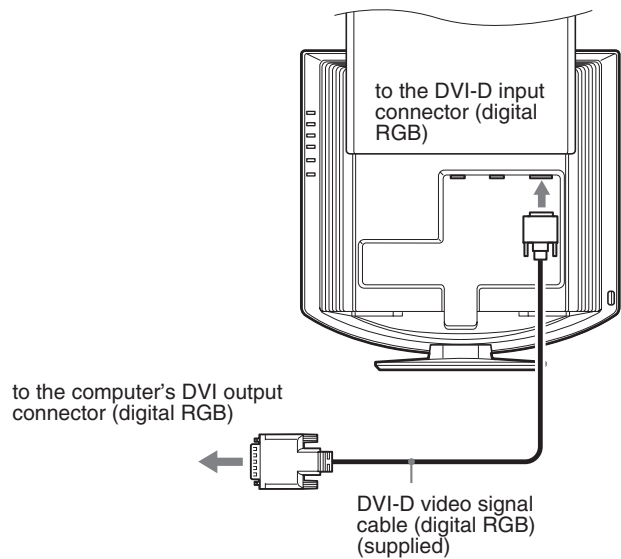

Connect a computer equipped with an HD15 output connector (analog RGB)

Using the supplied HD15-HD15 video signal cable (analog RGB), connect the computer to the monitor's HD 15 input connector (analog RGB) for INPUT1 or INPUT2.

Connect the computer according to the following illustrations.

■ Connecting to an IBM PC/AT or compatible computer

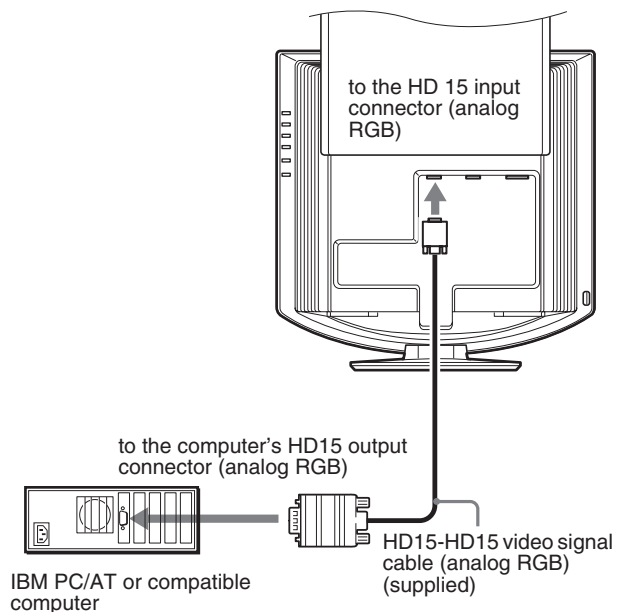

(continued)

■ Connecting to a Macintosh

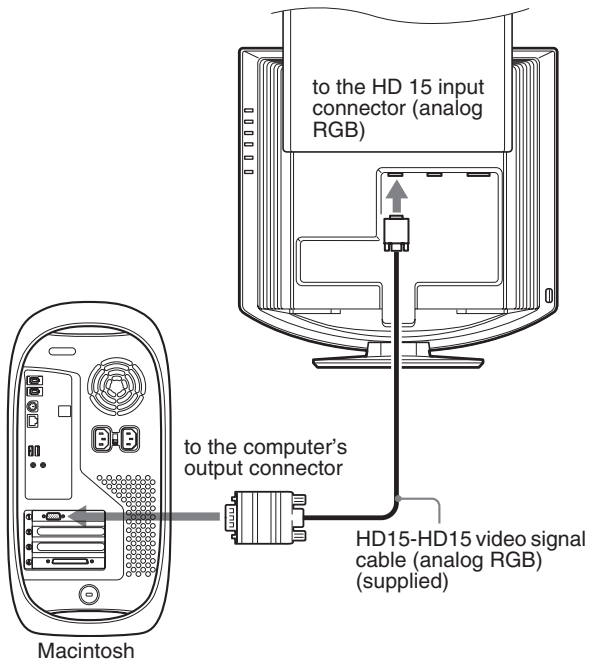

When connecting a Macintosh computer, use an adapter (not supplied), if necessary. Connect the adapter to the computer before connecting the video signal cable.

Setup 2: Connect the audio cord

Connect the supplied audio cord to the monitor's corresponding audio input jack.

Using the monitor's speakers or headphones, you can listen to sound from your computer or other audio equipment connected to the monitor's audio input jacks.

For more information, see "Controlling the volume" on page 19.

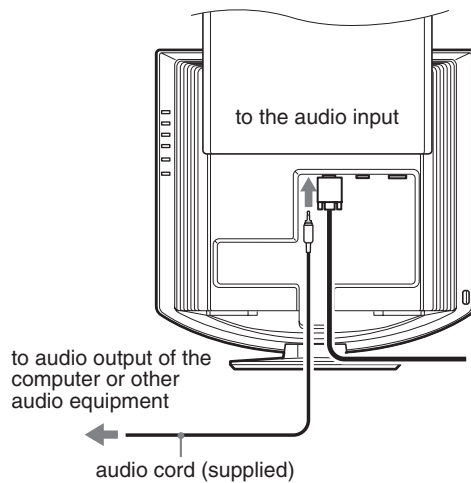

Setup 3: Connect the power cord

- 1 **Connect the supplied power cord securely to the monitor's AC IN connector.**
- 2 **Connect the other end securely to a power outlet.**

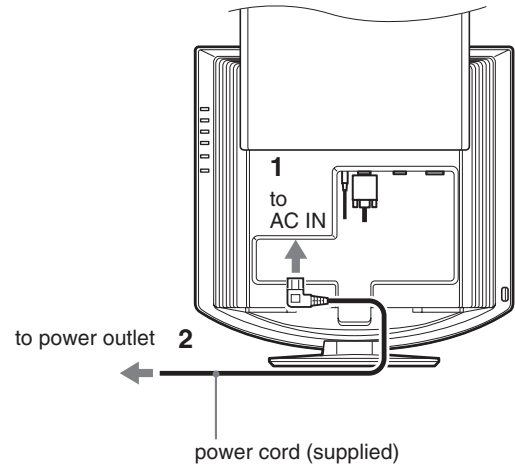

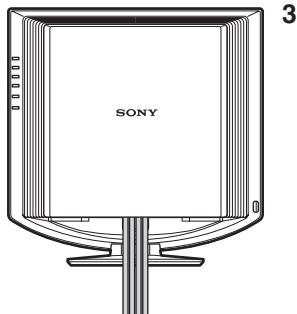
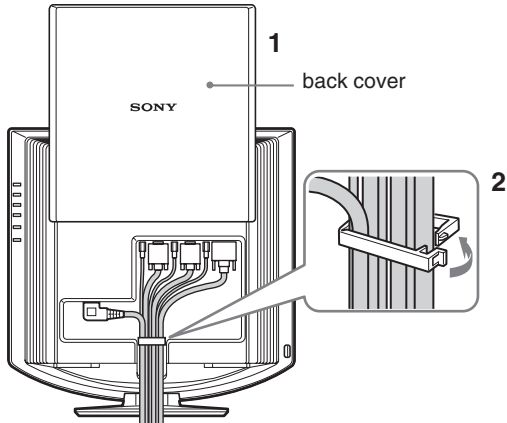

Setup 4: Bundle the cords and cables

- 1 Slide up the back cover.
- 2 Secure the video signal cable, audio cords and the power cord using the cable holder on the cabinet.
- 3 Slide down the back cover.



Setup 5: Turn on the monitor and computer

- 1 Press the  (power) switch on the front of the monitor.
The  (power) indicator lights up in green.

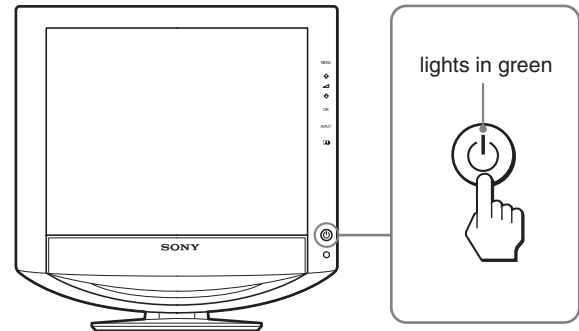

- 2 Turn on the computer.
- 3 Press the INPUT button to select the desired input signal.

The selected input's picture appears on the screen.
For more information, see "Selecting the input signal (INPUT button)" on page 11.



The installation of your monitor is complete. If necessary, use the monitor's controls to adjust the picture (page 12).

GB

(continued)

If no picture appears on your screen

- Check that the power cord and the video signal cable are properly connected.
- If “NO INPUT SIGNAL” appears on the screen:
 - The computer is in the power saving mode. Try pressing any key on the keyboard or moving the mouse.
 - Check that the input signal setting is correct by pressing the INPUT button (page 11).
- If “CABLE DISCONNECTED” appears on the screen:
 - Check that the video signal cable is properly connected.
 - Check that the input signal setting is correct by pressing the INPUT button (page 11).
- If “OUT OF RANGE” appears on the screen, reconnect the old monitor. Then adjust the computer’s graphics board within the following ranges.

	Analog RGB	Digital RGB
Horizontal frequency	28–80 kHz	28–64 kHz
Vertical frequency	48–75 Hz	60 Hz
Resolution	1280 × 1024 or less	1280 × 1024 or less

For more information about on-screen messages, see “Trouble symptoms and remedies” on page 22.

No need for specific drivers

The monitor complies with the “DDC” Plug & Play standard and automatically detects all the monitor’s information. No specific driver needs to be installed on the computer.

The first time you turn on your computer after connecting the monitor, the setup Wizard may appear on the screen. In this case, follow the on-screen instructions. The Plug & Play monitor is automatically selected so that you can use this monitor.

The vertical frequency is set to 60 Hz.

Since flickers are unobtrusive on the monitor, you can use it as it is. You do not need to set the vertical frequency to any particular high value.

Setup 6: Adjust the tilt and swivel

This monitor can be adjusted within the angles shown below.

Grasp the sides of the LCD panel, then adjust screen angles.

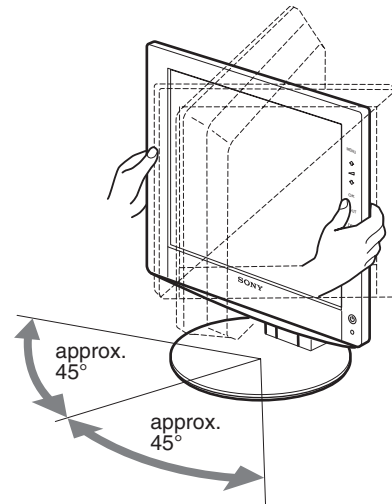
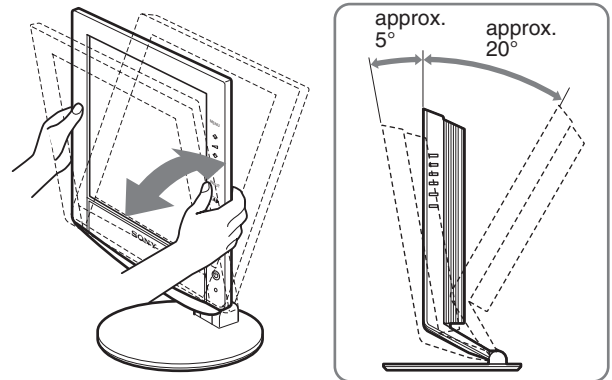

To use the monitor comfortably

Adjust the viewing angle of your monitor according to the height of your desk and chair, and so that light is not reflected from the screen to your eyes.

Note

When adjusting the screen tilt and height, proceed slowly and carefully, being sure not to hit the monitor against the desk.

Selecting the input signal (INPUT button)

Press the INPUT button.

The input signal change each time you press this button.



On-screen message (Appears about 5 seconds on the upper left corner.)	Input signal configuration
INPUT1: HD15	HD15 input connector (analog RGB) for INPUT1
INPUT2 : HD15	HD15 input connector (analog RGB) for INPUT2
INPUT3 : DVI-D	DVI-D input connector (digital RGB) for INPUT3

Customizing Your Monitor

Before making adjustments

Connect the monitor and the computer, and turn them on. For the best results, wait for at least 30 minutes before making adjustments.

You can make numerous adjustments to your monitor using the on-screen menu.

Navigating the menu

1 Display the main menu.

Press the MENU button to display the main menu on your screen.

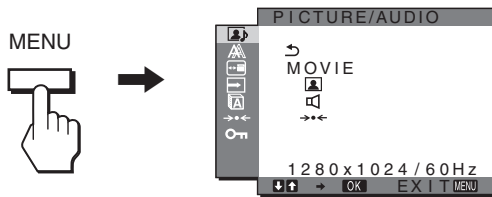

2 Select the menu.

Press the ↓/↑ buttons to display the desired menu. Press the OK button to move to the first menu item.

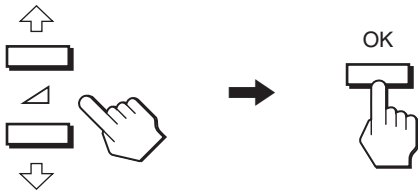

3 Select the item you want to adjust.

Press the ↓/↑ buttons to select the item you want to adjust, then press the OK button.

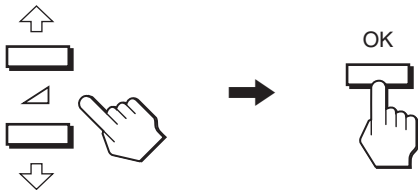

If ↶ is one of the menu items.

When you select ↶ and press the OK button, the display returns to the previous menu.

4 Adjust the item.

Press the ↓/↑ buttons to make the adjustment, then press the OK button.

When you press the OK button, the setting is stored, then the display returns to the previous menu.

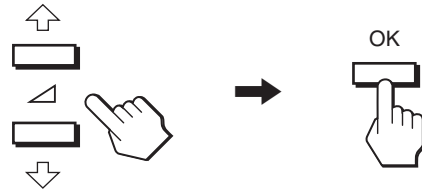

5 Close the menu.

Press the MENU button once to return to normal viewing. If no buttons are pressed, the menu closes automatically after about 45 seconds.



Resetting the adjustments to the default settings

You can reset the adjustments using RESET menu. For more information about resetting the adjustments, see → (RESET) on page 18.

PICTURE/AUDIO menu

You can adjust the following items using PICTURE/AUDIO menu.

- MODE (GAME/MOVIE/PC/AUTO)
- PICTURE
- AUDIO
- MODE RESET



MODE menu

You can select the appropriate screen brightness for your purpose. The PICTURE/AUDIO settings can be set for each mode. The changed setting is automatically applied for each input (INPUT1/INPUT2/INPUT3).

- 1 Press the MENU button.**
The main menu appears on the screen.
- 2 Press the ↓/↑ button to select (PICTURE/AUDIO) and press the OK button.**
The PICTURE/AUDIO menu appears on the screen.
- 3 Press the ↓/↑ button to select “MOVIE” and press the OK button.**
The MODE menu appears on the screen.

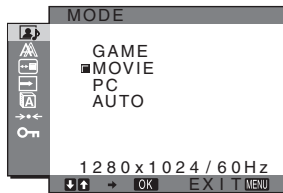

- 4 Press the ↓/↑ button to select the desired mode and press the OK button.**
The default setting is MOVIE.
 - GAME: Bright picture.
 - MOVIE: Clear picture with strong contrast.
 - PC: Soft tone picture.
 - AUTO: Automatically adjusts the screen brightness according to the brightness of the surroundings (automatic brightness adjustment function). For more information, see “Automatic brightness adjustment function (light sensor)” (page 20).

NOTE

In the AUTO mode, you cannot adjust the backlight.

PICTURE menu

You can adjust the following items using the PICTURE menu.

- BACKLIGHT
- CONTRAST
- BRIGHTNESS
- GAMMA menu
- COLOR menu
- SHARPNESS

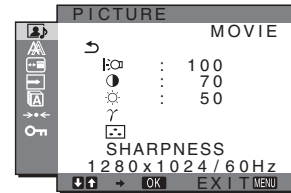

Adjusting the BACKLIGHT

If the screen is too bright, adjust the backlight to make the screen easier to see.

- 1 Press the MENU button.**
The main menu appears on the screen.
- 2 Press the ↓/↑ button to select (PICTURE/AUDIO) and press the OK button.**
The PICTURE/AUDIO menu appears on the screen.
- 3 Press the ↓/↑ buttons to select (PICTURE) and press the OK button.**
The PICTURE menu appears on the screen.
- 4 Press the ↓/↑ buttons to select “BACKLIGHT” and press the OK button.**
The “BACKLIGHT” menu appears on the screen.
- 5 Press the ↓/↑ buttons to adjust the light level and press the OK button.**

Adjusting the CONTRAST

Adjust the picture contrast.



- 1 Press the MENU button.**
The main menu appears on the screen.
- 2 Press the ↓/↑ button to select (PICTURE/AUDIO) and press the OK button.**
The PICTURE/AUDIO menu appears on the screen.
- 3 Press the ↓/↑ buttons to select (PICTURE) and press the OK button.**
The PICTURE menu appears on the screen.
- 4 Press the ↓/↑ buttons to select “CONTRAST” and press the OK button.**
The “CONTRAST” menu appears on the screen.
- 5 Press the ↓/↑ buttons to adjust the contrast and press the OK button.**

GB

(continued)

Adjusting the BRIGHTNESS



Adjust the picture brightness (black level).

- 1 Press the MENU button.**
The main menu appears on the screen.
- 2 Press the ↓/↑ button to select  (PICTURE/AUDIO) and press the OK button.**
The PICTURE/AUDIO menu appears on the screen.
- 3 Press the ↓/↑ buttons to select  (PICTURE) and press the OK button.**
The PICTURE menu appears on the screen.
- 4 Press the ↓/↑ buttons to select “ BRIGHTNESS” and press the OK button.**
The “BRIGHTNESS” menu appears on the screen.
- 5 Press the ↓/↑ buttons to adjust the brightness and press the OK button.**

Adjusting the GAMMA γ

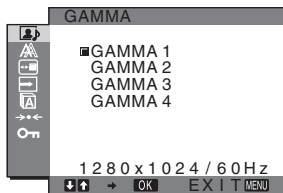
You can associate the picture’s color shade on the screen with the picture’s original color shade.



- 1 Press the MENU button.**
The main menu appears on the screen.
- 2 Press the ↓/↑ button to select  (PICTURE/AUDIO) and press the OK button.**
The PICTURE/AUDIO menu appears on the screen.
- 3 Press the ↓/↑ buttons to select  (PICTURE) and press the OK button.**
The PICTURE menu appears on the screen.
- 4 Press the ↓/↑ buttons to select “ γ (GAMMA)” and press the OK button.**
The GAMMA menu appears on the screen.
- 5 Press the ↓/↑ buttons to select the desired mode and press the OK button.**



Adjusting the COLOR

You can select the picture’s color level for the white color field from the default color temperature settings.

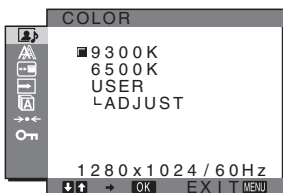
Also, if necessary, you can fine tune the color temperature.





- 1 Press the MENU button.**
The main menu appears on the screen.

- 2 Press the ↓/↑ button to select  (PICTURE/AUDIO) and press the OK button.**
The PICTURE/AUDIO menu appears on the screen.
- 3 Press the ↓/↑ buttons to select  (PICTURE) and press the OK button.**
The PICTURE menu appears on the screen.
- 4 Press the ↓/↑ buttons to select “ (COLOR)” and press the OK button.**
The COLOR menu appears on the screen.
- 5 Press the ↓/↑ buttons to select the desired color temperature and press the OK button.**
White balance changes from bluish to reddish as the color temperature is adjusted from 9300K to 6500K.

Fine tuning the color temperature

The color temperature can be set for each mode (GAME/MOVIE/PC/AUTO).

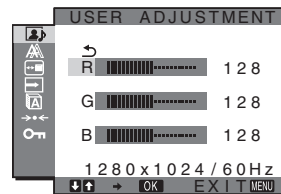

- 1 Press the MENU button.**
The main menu appears on the screen.
- 2 Press the ↓/↑ button to select  (PICTURE/AUDIO) and press the OK button.**
The PICTURE/AUDIO menu appears on the screen.
- 3 Press the ↓/↑ buttons to select  (PICTURE) and press the OK button.**
The PICTURE menu appears on the screen.
- 4 Press the ↓/↑ buttons to select “ (COLOR)” and press the OK button.**
The COLOR menu appears on the screen.
- 5 Press the ↓/↑ buttons to select “ADJUST” and press the OK button.**
The fine tuning menu for color temperature appears on the screen.



- 6 Press the ↓/↑ buttons to select R (Red) or B (Blue) and press the OK button. Then press the ↓/↑ buttons to adjust the color temperature and press the OK button.**
Since this adjustment changes the color temperature by increasing or decreasing the R and B components with respect to G (green), the G component is fixed.
- 7 Press the ↓/↑ buttons to select , then press the OK button.**
The new color setting is stored in memory and automatically recalled whenever “User” is selected.
The COLOR menu appears on the screen.

Adjusting the SHARPNESS

Adjust to sharpen the edge of images, etc.

- 1 **Press the MENU button.**
The main menu appears on the screen.
- 2 **Press the ↓/↑ button to select  (PICTURE/AUDIO) and press the OK button.**
The PICTURE/AUDIO menu appears on the screen.
- 3 **Press the ↓/↑ buttons to select  (PICTURE) and press the OK button.**
The PICTURE menu appears on the screen.
- 4 **Press the ↓/↑ buttons to select “SHARPNESS” and press the OK button.**
The “SHARPNESS” menu appears on the screen.
- 5 **Press the ↓/↑ buttons to adjust the sharpness and press the OK button.**



■ AUDIO menu

You can adjust the following items using the AUDIO menu.

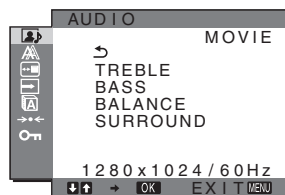

- TREBLE
- BASS
- BALANCE
- SURROUND



Adjusting TREBLE, BASS or BALANCE

- 1 **Press the MENU button.**
The main menu appears on the screen.
- 2 **Press the ↓/↑ button to select  (PICTURE/AUDIO) and press the OK button.**
The PICTURE/AUDIO menu appears on the screen.
- 3 **Press the ↓/↑ buttons to select  (AUDIO) and press the OK button.**
- 4 **Press the ↓/↑ buttons to select TREBLE, BASS or BALANCE, and press the OK button.**
- 5 **Press the ↓/↑ buttons to select the desired mode and press the OK button.**

Adjusting SURROUND

- 1 **Press the MENU button.**
The main menu appears on the screen.
- 2 **Press the ↓/↑ button to select  (PICTURE/AUDIO) and press the OK button.**
The PICTURE/AUDIO menu appears on the screen.
- 3 **Press the ↓/↑ buttons to select  (AUDIO) and press the OK button.**
- 4 **Press the ↓/↑ buttons to select SURROUND and press the OK button.**

- 5 **Press the ↓/↑ buttons to select the desired mode and press the OK button.**

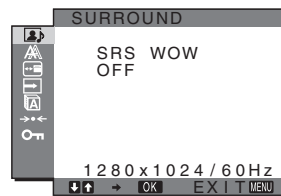

- **SRS WOW:** Deep rich bass tone and clear high tone creates a rich surround sound experience, and movies and games, especially, can be enjoyed with powerful sound.
- **OFF:** Turns off the SRS WOW effect.

Adopting the latest technology developed by SRS Labs, Inc., SRS WOW significantly improves the sound quality of various audio sources.

■ MODE RESET menu (resetting every mode to the default) →←

You can reset the adjustments to the default settings.

- 1 **Press the MENU button.**
The main menu appears on the screen.
- 2 **Press the ↓/↑ button to select  (PICTURE/AUDIO) and press the OK button.**
The PICTURE/AUDIO menu appears on the screen.
- 3 **Press the ↓/↑ buttons to select “→← RESET” and press the OK button.**
The “RESET” menu appears on the screen.
- 4 **Press the ↓/↑ buttons to select the desired mode and press the OK button.**
 - **OK:** To reset every mode in the PICTURE/AUDIO menu to the default settings.
 - **CANCEL:** To cancel resetting and return to the PICTURE/AUDIO menu.

GB

SCREEN menu (analog RGB signal only)

You can adjust the following items using the SCREEN menu.

- AUTO
- PHASE
- PITCH
- H CENTER
- V CENTER

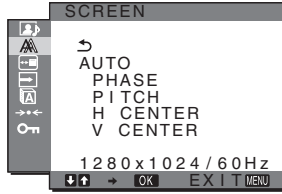

Note

When receiving digital RGB signals from the DVI-D input connector for INPUT3, adjustment is unnecessary.

Automatic picture quality adjustment function

When the monitor receives an input signal, it automatically adjusts the picture's position and sharpness (phase/pitch), and ensures that a clear picture appears on the screen (page 20).

Note

While the automatic picture quality adjustment function is activated, only the  (power) switch will operate.

If the automatic picture quality adjustment function of this monitor seems to not completely adjust the picture

You can make further automatic adjustment of the picture quality for the current input signal (See "AUTO" below).

If you still need to make further adjustments to the picture quality

You can manually adjust the picture's sharpness (phase/pitch) and position (horizontal/vertical position).

These adjustments are stored in memory and automatically recalled when the monitor receives a previously input and registered input signal.

Make further automatic adjustments to the picture quality for the current input signal (AUTO)

- 1 Press the MENU button.**
The main menu appears on the screen.
- 2 Press the ↓/↑ buttons to select  (SCREEN) and press the OK button.**
The SCREEN menu appears on the screen.
- 3 Press the ↓/↑ buttons to select "AUTO" and press the OK button.**
Make the appropriate adjustments of the screen's phase, pitch and horizontal/vertical position for the current input signal and store them.

Adjust the picture's sharpness manually (Phase/Pitch)

You can adjust the picture's sharpness as follows. This adjustment is effective when the computer is connected to the monitor's HD15 input connector (analog RGB).

- 1 Set the resolution to 1280 × 1024 on the computer.**
- 2 Load the CD-ROM.**
- 3 Start the CD-ROM, select the area and model, and display the test pattern.**

For Windows

Click [Utility] → [Windows]/[Win Utility.exe].

For Macintosh

Click [Utility] → [Mac]/[Mac Utility].

- 4 Press the MENU button.**
The main menu appears on the screen.
- 5 Press the ↓/↑ buttons to select  (SCREEN) and press the OK button.**
The SCREEN menu appears on the screen.
- 6 Press the ↓/↑ buttons to select "PHASE" and press the OK button.**
The "PHASE" adjustment menu appears on the screen.
- 7 Press the ↓/↑ buttons until the horizontal stripes are at a minimum.**
Adjust so that the horizontal stripes are at a minimum.

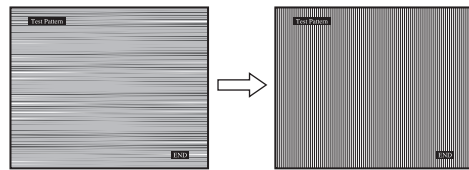

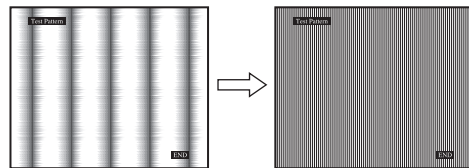

- 8 Press the OK button.**
The main menu appears on the screen.
If vertical stripes are observed over the entire screen, adjust the pitch using the following procedures.
- 9 Press the ↓/↑ buttons to select "PITCH" and press the OK button.**
The "PITCH" adjustment menu appears on the screen.
- 10 Press the ↓/↑ buttons until the vertical stripes disappear.**
Adjust so that the vertical stripes disappear.



- 11 Click [END] on the screen to turn off the test pattern.**

■ Adjust the picture's position manually (H CENTER / V CENTER)

If the picture is not in the center of the screen, adjust the picture's centering as follows.

- 1 Set the resolution to 1280 × 1024 on the computer.**
- 2 Load the CD-ROM.**
- 3 Start the CD-ROM, select the area and model, and display the test pattern.**
For Windows
Click [Utility] → [Windows]/[Win Utility.exe].
For Macintosh
Click [Utility] → [Mac]/[Mac Utility].
- 4 Press the MENU button.**
The main menu appears on the screen.
- 5 Press the ↓/↑ buttons to select  (SCREEN) and press the OK button.**
The SCREEN menu appears on the screen.
- 6 Press the ↓/↑ buttons to select "H CENTER" or "V CENTER" and press the OK button.**
The "H CENTER" adjustment menu or "V CENTER" adjustment menu appears on the screen.
- 7 Press the ↓/↑ buttons to center the test pattern on the screen.**
- 8 Click  on the screen to turn off the test pattern.**

MENU POSITION menu

You can change the menu position if it is blocking an image on the screen.

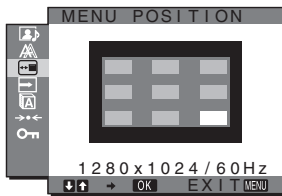

- 1 Press the MENU button.**
The main menu appears on the screen.
- 2 Press the ↓/↑ buttons to select  (MENU POSITION) and press the OK button.**
The "MENU POSITION" menu appears on the screen.
- 3 Press the ↓/↑ buttons to select the desired position and press the OK button.**
You can choose one of 9 positions where the menu will appear.

INPUT SENSING ON/OFF menu

When you select AUTO ON in the INPUT SENSING ON/OFF menu, the monitor automatically detects an input signal to an input terminal, and changes the input automatically before the monitor goes into the power saving mode.

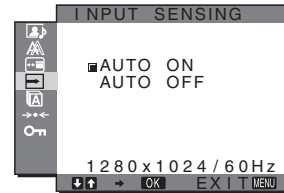

- 1 Press the MENU button.**
The main menu appears on the screen.
- 2 Press the ↓/↑ buttons to select  (INPUT SENSING ON/OFF) and press the OK button.**
The INPUT SENSING menu appears on the screen.
- 3 Press the ↓/↑ buttons to select the desired mode and press the OK button.**
 - ON:** When the selected input terminal has no input signal, or when you select an input terminal by the INPUT button on the monitor and the terminal has no input signal, the on-screen message appears (page 21) and the monitor checks the input signal to another input terminal automatically to change the input.
When the input is changed, the selected input terminal is displayed on the left upper of the screen. When there is no input signal, the monitor goes into the power saving mode automatically.
 - OFF:** The input is not changed automatically. Press the INPUT button to change the input.

GB

(continued)

LANGUAGE menu







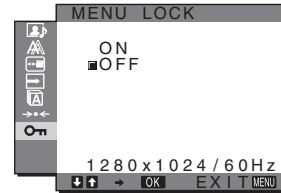

- 1 Press the MENU button.**
The main menu appears on the screen.
- 2 Press the ↓/↑ buttons to select  (LANGUAGE) and press the OK button.**
The LANGUAGE menu appears on the screen.
- 3 Press the ↓/↑ buttons to select a language and press the OK button.**
 - English
 - Français: French
 - Deutsch: German
 - Español: Spanish
 - Italiano: Italian
 - Nederlands: Dutch
 - Svenska: Swedish
 - Русский: Russian
 - 日本語: Japanese
 - 中文: Chinese

MENU LOCK menu



Lock the control of buttons to prevent accidental adjustments or resetting.

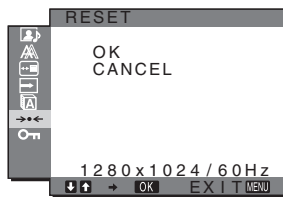

- 1 Press the MENU button.**
The main menu appears on the screen.
- 2 Press the ↓/↑ buttons to select  (MENU LOCK) and press the OK button.**
The MENU LOCK menu appears on the screen.
- 3 Press the ↓/↑ buttons to select either “On” or “Off.”**
 - ON: Only the  (power) switch and INPUT button will operate. If you attempt any other operation, the  icon appears on the screen.
 - OFF: Set “ MENU LOCK” to off. If “ MENU LOCK” has been set to “ON,” when you press the MENU button, “ MENU LOCK” is automatically selected.

RESET menu (reset to the default setting)



- 1 Press the MENU button.**
The main menu appears on the screen.
- 2 Press the ↓/↑ buttons to select  (RESET) and press the OK button.**
The RESET menu appears on the screen.
- 3 Press the ↓/↑ buttons to select the desired mode and press the OK button.**
 - OK: To reset all of the adjustment data to the default settings. Note that the “ LANGUAGE” setting is not reset by this method.
 - CANCEL: To cancel resetting and return to the menu screen.

Technical Features

Controlling the volume

Using the monitor's speakers or headphones, you can listen to sound from your computer or other audio equipment connected to the monitor's audio input jacks.

You can control the volume by using a separate "Volume" menu from the main menu.

- 1 Press the ↓/↑ buttons when no menu appears on the screen.

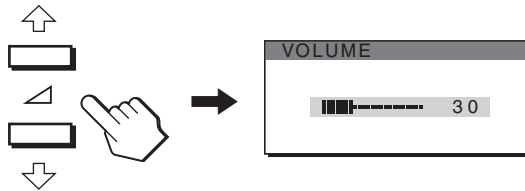

- 2 Press the ↓/↑ buttons to control the volume. The menu automatically disappears after about 5 seconds.

Notes

- You cannot adjust the volume when the main menu is displayed on the screen.
- When your monitor is in power saving mode, no sound comes from the speakers or the headphones.

Power saving function

This monitor meets the power-saving guidelines set by VESA, ENERGY STAR, and NUTEK. If the monitor is connected to a computer or video graphics board that is DPMS (Display Power Management Signaling) compliant, the monitor will automatically reduce power consumption as shown below.

SDM-HX73

Power mode	Power consumption	⏻ (power) indicator
normal operation	50 W (max.)	green
active off* (deep sleep)**	1 W (max.)	amber
⏻ (power) off	1 W (max.)	off

SDM-HX93

Power mode	Power consumption	⏻ (power) indicator
normal operation	60 W (max.)	green
active off* (deep sleep)**	1 W (max.)	amber
⏻ (power) off	1 W (max.)	off

* When your computer enters the "active off" mode, the input signal is cut and "NO INPUT SIGNAL" appears on the screen. After 5 seconds, the monitor enters the power saving mode.

** "Deep sleep" is a power saving mode defined by the Environmental Protection Agency.

Setting the MODE (PICTURE/AUDIO) (mode)

If you press the  button on the right side of the monitor repeatedly, you can select the MODE from GAME → MOVIE → PC → AUTO.

When you select “AUTO,” the monitor automatically adjusts the screen brightness according to the brightness of the surroundings (Automatic brightness adjustment function). For more information, see “Automatic brightness adjustment function (light sensor)”.

Press the button repeatedly.



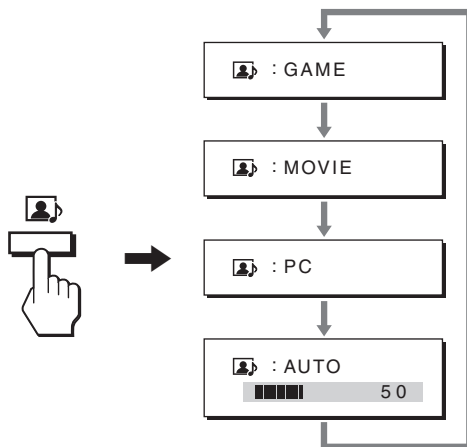

The default setting of the MODE is set to “MOVIE”. When you press the  button once, “MOVIE” (the default setting) is displayed, and when you press again, “PC” is displayed.

Each time you press the  button, the mode changes as follows.



Each mode appears on the screen and the MODE is changed. The menu automatically disappears after about 5 seconds.

Automatic brightness adjustment function (light sensor)

This monitor is provided with a feature to automatically adjust the screen brightness according to the brightness of the surroundings. The brightness of the screen is set to the most appropriate level by setting the  mode to AUTO with the  button on the right side of the monitor, or in the PICTURE/AUDIO menu. The default setting of the brightness of the screen is set to MOVIE. Also, when you set the  mode to AUTO with the  button on the right side of the monitor, the adjustment bar is also displayed. You can adjust the bar with the ↓/↑ buttons. Screen brightness changes according to the level you set.

Automatic picture quality adjustment function (analog RGB signal only)

When the monitor receives an input signal, it automatically adjusts the picture’s position and sharpness (phase/pitch), and ensures that a clear picture appears on the screen.

The factory preset mode

When the monitor receives an input signal, it automatically matches the signal to one of the factory preset modes stored in the monitor’s memory to provide a high quality picture at the center of the screen. If the input signal matches the factory preset mode, the picture appears on the screen automatically with the appropriate default adjustments.

If input signals do not match one of the factory preset modes

When the monitor receives an input signal that does not match one of the factory preset modes, the automatic picture quality adjustment function of this monitor is activated to ensure that a clear picture always appears on the screen (within the following monitor frequency ranges):

Horizontal frequency: 28–80 kHz

Vertical frequency: 48–75 Hz

Consequently, the first time the monitor receives input signals that do not match one of the factory preset modes, the monitor may take a longer time than normal to display the picture on the screen. This adjustment data is automatically stored in memory so that next time, the monitor will function in the same way as when the monitor receives the signals that match one of the factory preset modes.

If you adjust the phase, pitch, and picture position manually

For some input signals, the automatic picture quality adjustment function of this monitor may not completely adjust the picture position, phase, and pitch. In this case, you can set these adjustments manually (page 16). If you set these adjustments manually, they are stored in memory as user modes and automatically recalled whenever the monitor receives the same input signals.

Troubleshooting

Before contacting technical support, refer to this section.

On-screen messages

If there is something wrong with the input signal, one of the following messages appears on the screen. To solve the problem, see “Trouble symptoms and remedies” on page 22.

If “OUT OF RANGE” appears on the screen

This indicates that the input signal is not supported by the monitor’s specifications. Check the following items.

For more information about on-screen messages, see “Trouble symptoms and remedies” on page 22.

If “xxx.x kHz / xxx Hz” is displayed

This indicates that either the horizontal or vertical frequency is not supported by the monitor’s specifications.

The figures indicate the horizontal and vertical frequencies of the current input signal.

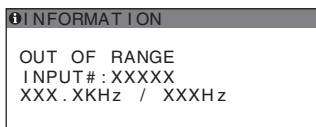

If “RESOLUTION > 1280 × 1024” is displayed

This indicates that the resolution is not supported by the monitor’s specifications (1280 × 1024 or less).

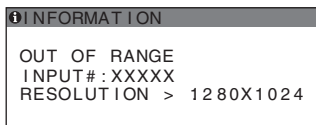

If “NO INPUT SIGNAL” appears on the screen

This indicates that no signal is being input via the currently selected connector.

When INPUT SENSING ON/OFF (page 17) is set to ON, the monitor finds another input signal and changes the input automatically.

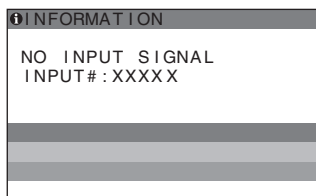

If “CABLE DISCONNECTED” appears on the screen



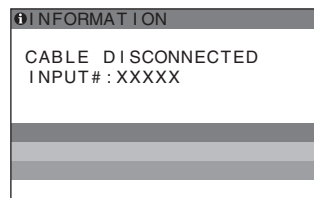

This indicates that the video signal cable has been disconnected from the currently selected connector.



When INPUT SENSING ON/OFF (page 17) is set to ON, the monitor finds another input signal and changes the input automatically.



Trouble symptoms and remedies

If a problem occurs as a result of a connected computer or other equipment, refer to the connected computer/equipment's instruction manual. Use the self-diagnosis function (page 24) if the following recommendations do not resolve the problem.

Symptom	Check these items
No picture	
If the  (power) indicator is not lit, or if the  (power) indicator will not light up when the  (power) switch is pressed,	<ul style="list-style-type: none"> • Check that the power cord is properly connected.
If the  (power) indicator is green,	<ul style="list-style-type: none"> • Use the self-diagnosis function (page 24).
If "CABLE DISCONNECTED" appears on the screen,	<ul style="list-style-type: none"> • Check that the video signal cable is properly connected and all plugs are firmly seated in their sockets (page 7). • Check that the video input connector's pins are not bent or pushed in. • Check that the input select setting is correct (page 11). • A non-supplied video signal cable is connected. If you connect a non-supplied video signal cable, "CABLE DISCONNECTED" may appear on the screen. This is not a malfunction.
If "NO INPUT SIGNAL" appears on the screen, or the  (power) indicator is amber,	<ul style="list-style-type: none"> • Check that the video signal cable is properly connected and all plugs are firmly seated in their sockets (page 7). • Check that the video input connector's pins are not bent or pushed in. • Check that the input select setting is correct (page 11). <p>■Problem caused by a connected computer or other equipment, and not caused by the monitor</p> <ul style="list-style-type: none"> • The computer is in the power saving mode. Try pressing any key on the keyboard or moving the mouse. • Check that your graphics board is installed properly. • Check that the computer's power is on.
If "OUT OF RANGE" appears on the screen (page 21),	<p>■Problem caused by a connected computer or other equipment, and not caused by the monitor</p> <ul style="list-style-type: none"> • Check that the video frequency range is within that specified for the monitor. If you replaced an old monitor with this monitor, reconnect the old monitor and adjust the computer's graphics board within the following ranges: Horizontal frequency: 28–80 kHz (Analog RGB), 28–64 kHz (Digital RGB) Vertical frequency: 48–75 Hz (Analog RGB), 60 Hz (Digital RGB) Resolution: 1280 × 1024 or less
If using Windows,	<ul style="list-style-type: none"> • If you replaced an old monitor with this monitor, reconnect the old monitor and do the following. Select "SONY" from the "Manufacturers" list and select "SDM-HX73 or SDM-HX93" from the "Models" list in the Windows device selection screen. If "SDM-HX73 or SDM-HX93" does not appear in the "Models" list, try "Plug & Play."
If using a Macintosh system,	<ul style="list-style-type: none"> • When connecting a Macintosh computer, use an adapter (not supplied) if necessary. Connect the adapter to the computer before connecting the video signal cable.
Picture flickers, bounces, oscillates, or is scrambled.	<ul style="list-style-type: none"> • Adjust the pitch and phase (analog RGB signal only) (page 16). • Isolate and eliminate any potential sources of electric or magnetic fields such as other monitors, laser printers, electric fans, fluorescent lighting, or televisions. • Move the monitor away from power lines or place a magnetic shield near the monitor. • Try plugging the monitor into a different AC outlet, preferably on a different circuit. • Change the orientation of the monitor. <p>■Problem caused by a connected computer or other equipment, and not caused by the monitor</p> <ul style="list-style-type: none"> • Check your graphics board manual for the proper monitor setting. • Confirm that the graphics mode (VESA, Macintosh 19" Color, etc.) and the frequency of the input signal are supported by this monitor. Even if the frequency is within the proper range, some graphics boards may have a sync pulse that is too narrow for the monitor to sync with correctly. • This monitor does not process interlace signals. Set for progressive signals. • Adjust the computer's refresh rate (vertical frequency) to obtain the best possible picture (60 Hz is recommended).

Symptom	Check these items
Picture is fuzzy.	<ul style="list-style-type: none"> • Adjust the contrast and brightness (page 13, 14). • Adjusting the sharpness (page 15). • Adjust the pitch and phase (analog RGB signal only) (page 16). <p>■ Problem caused by a connected computer or other equipment, and not caused by the monitor</p> <ul style="list-style-type: none"> • Set the resolution to 1280 × 1024 on your computer.
Picture is ghosting.	<ul style="list-style-type: none"> • Eliminate the use of video cable extensions and/or video switch boxes. • Check that all plugs are firmly seated in their sockets.
Picture is not centered or sized properly (analog RGB signal only).	<ul style="list-style-type: none"> • Adjust the pitch and phase (page 16). • Adjust the picture position (page 17). Note that some video modes do not fill the screen to the edges.
Picture is too small.	<p>■ Problem caused by a connected computer or other equipment, and not caused by the monitor</p> <ul style="list-style-type: none"> • Set the resolution to 1280 × 1024 on your computer.
Picture is dark.	<ul style="list-style-type: none"> • Adjust the backlight (page 13). • Adjust the brightness (page 14). • Adjust the gamma on the GAMMA menu (page 14). • It takes a few minutes for the display to become bright after turning on the monitor. • When the  mode is set to AUTO, the display brightness may become dark in low ambient light (page 13, 20).
Wavy or elliptical pattern (moire) is visible.	<ul style="list-style-type: none"> • Adjust the pitch and phase (analog RGB signal only) (page 16).
Color is not uniform.	<ul style="list-style-type: none"> • Adjust the pitch and phase (analog RGB signal only) (page 16).
White does not look white.	<ul style="list-style-type: none"> • Adjust the color temperature (page 14).
Monitor buttons do not operate ( appears on the screen).	<ul style="list-style-type: none"> • If “MENU LOCK” is set to “ON,” set it to “OFF” (page 18).
Resolution displayed on the menu screen is incorrect.	<ul style="list-style-type: none"> • Depending on the graphics board setting, the resolution displayed on the menu screen may not coincide with the one set on the computer.

Displaying this monitor's information

While the monitor is receiving a video signal, press and hold the MENU button for more than 5 seconds until the information box appears.

Press the MENU button again to make the box disappear.

Example

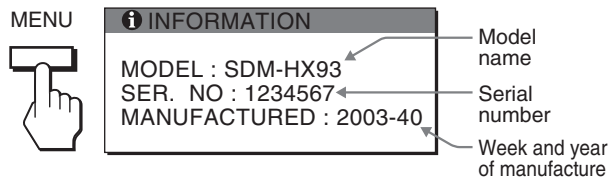

If any problem persists, call your authorized Sony dealer and give the following information:

- Model name: SDM-HX73 or SDM-HX93
- Serial number
- Detailed description of the problem
- Date of purchase
- Name and specifications of your computer and graphics board
- Type of input signals (analog RGB/digital RGB)

Self-diagnosis function

This monitor is equipped with a self-diagnosis function. If there is a problem with your monitor or computer(s), the screen will go blank and the ⏻ (power) indicator will light up green. If the ⏻ (power) indicator is lit in amber, the computer is in power saving mode. Try pressing any key on the keyboard or moving the mouse.

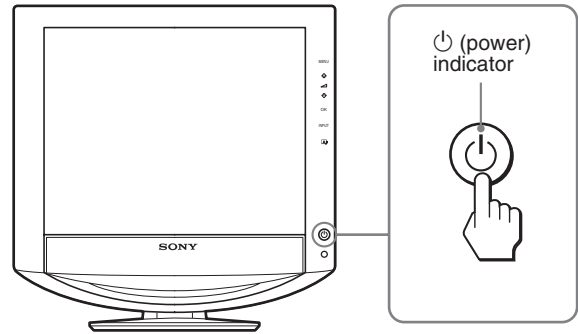

If the picture disappears from the screen and the ⏻ (power) indicator is green

- 1 Turn off the ⏻ (power) switch and disconnect the video signal cables from the monitor.
- 2 Turn the monitor on by pressing the ⏻ (power) switch.

If all four color bars appear (white, red, green, blue), the monitor is working properly. Reconnect the video input cables and check the condition of your computer(s).

If the color bars do not appear, there is a potential monitor failure. Inform your authorized Sony dealer of the monitor's condition.

If the ⏻ (power) indicator lights up in amber

Try pressing any key on the keyboard or moving the mouse.

The computer's power saving mode is shut off and the ⏻ (power) indicator lights up in green, and the picture appears on the screen.

Specifications

LCD panel	Panel type: a-Si TFT Active Matrix Picture size: 17 inch (43 cm) (SDM-HX73) 19 inch (48 cm) (SDM-HX93)
Input signal format	RGB operating frequency* Horizontal: 28–80 kHz (analog RGB) 28–64 kHz (digital RGB) Vertical: 48–75 Hz (analog RGB) 60 Hz (digital RGB)
Resolution	Horizontal: Max.1280 dots Vertical: Max.1024 lines
Input signal levels	Analog RGB video signal: 0.7 V _{p-p} , 75 Ω positive SYNC signal: TTL level, 2.2 kΩ positive or negative (Separate horizontal and vertical, or composite sync) Digital RGB (DVI) signal: TMDS (Single link)
Audio input	Stereo minijack, 0.5 V _{rms}
Speaker output	3 W × 2
Headphones jack	Stereo minijack
Power requirements	SDM-HX73 100–240 V, 50–60 Hz, Max. 1.0 A SDM-HX93 100–240 V, 50–60 Hz, Max. 1.1 A
Power consumption	Max. 50 W (SDM-HX73) Max. 60 W (SDM-HX93)
Operating temperature	5–35 °C
Dimensions (width/height/depth)	Display (upright): SDM-HX73 Approx. 414 × 418.5 × 232 mm (16 ³ / ₈ × 16 ¹ / ₂ × 9 ¹ / ₄ inches) SDM-HX93 Approx. 466.5 × 468 × 265 mm (18 ³ / ₈ × 18 ¹ / ₂ × 10 ¹ / ₂ inches)
Mass	SDM-HX73 Approx. 6.5 kg (14 lb 5 oz) SDM-HX93 Approx. 8.5 kg (18 lb 12 oz)
Plug & Play	DDC2B
Accessories	See page 7.

- * Recommended horizontal and vertical timing condition
- Horizontal sync width duty should be more than 4.8% of total horizontal time or 0.8 μsec, whichever is larger.
 - Horizontal blanking width should be more than 2.5 μsec.
 - Vertical blanking width should be more than 450 μsec.

Design and specifications are subject to change without notice.